

Windows fastening in insulated clay masonry walls

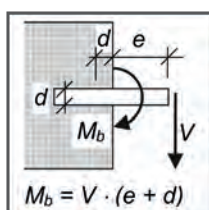

Short Report

Topic	Fastening of windows in vertically perforated clay masonry units with high thermal insulating properties
Short title	Window fastening in insulated clay masonry walls
Funded by	Forschungsinitiative Zukunft Bau des Bundesinstitutes für Bau-, Stadt- und Raumforschung (Aktenzeichen: SWD-10.08.18.7-13.27)
Research centre	ift gemeinnützige Forschungs- und Entwicklungsgesellschaft mbH Theodor-Gietl-Straße 7-9 83026 Rosenheim
Official in charge	Jaroslav Novak Martin Heßler Wolfgang Jehl Norbert Sack
Project Manager	Wolfgang Jehl
Director of the Institute	Professor Ulrich Sieberath

Rosenheim, April 2018

The research project based on this report was sponsored by funds of the research initiative "Zukunft Bau" of the Bundesamt für Bauwesen und Raumordnung (Federal Office for Building and Regional Planning). SWD-10.08.18.7-13.27).

The authors are responsible for the contents of this report.



Table of Contents

1 Motivation and Project Goal	Fehler! Textmarke nicht definiert.
2 Procedure	Fehler! Textmarke nicht definiert.
3 Results	Fehler! Textmarke nicht definiert.
4 Acknowledgement	Fehler! Textmarke nicht definiert.



1 Motivation and Project Goal

The stringent and increasingly more stringent requirements for construction-related thermal insulation lead to the following developments:

Monolithic clay unit masonry

In order to meet the requirements for more stringent thermal insulation of walls, the thermal conductivity of clay unit masonry has been reduced considerably in recent years.

By

- increasing the proportion of perforations and their arrangement,
- lower web thickness,
- reduced cullet raw density as well as
- masonry units filled with insulating material,

you can achieve values of thermal conductivity well below 0.10 W/(m K) .

However, together with the associated improvement in the thermal properties, this led to a reduction in mechanical strengths at the same time.

Building elements such as windows and casement doors

The use of 3-pane glass will become standard in future for reducing the thermal transmittance U of windows and other transparent building elements.

The trend towards transparent construction leads to building elements and thus, to larger glass surfaces.

The requirements for comfort (e.g. sound insulation) as well as security (e.g. burglar-resistance) will also become more stringent in future. As a result of this, insulating glass units with composite panes will be used increasingly.

As a result of these developments, both at present, and in the future, there will be considerably higher weights of transparent building elements.

Based on architectonic requirements, installation situations need to be implemented increasingly in which the building element moves progressively outwards in the window reveal.

With the use of additional exterior thermal insulation, the building element is placed in front of the masonry, which leads to another fixing situation and makes it necessary to use load-bearing aids (brackets).

The above-mentioned aspects led to the following consequences:

The fastening of windows and casement doors in clay unit masonry with high thermal insulation properties is becoming increasingly more difficult using conventional methods. There are no generally acknowledged and agreed fixing solutions taking other building elements into account (e.g. roller shutter boxes).

There is the risk that clay unit masonry with high thermal insulation properties loses acceptance by architects, planners and building owners.

Apart from the general issue of difficulty of fastening in clay unit masonry with high thermal insulation properties, there are other concrete issues that arise in practice.

Another matter concerning fixing or fastening concerns safety barrier glazing. It must be possible to bear the loads occurring here safely even in clay unit masonry with high thermal insulating properties. At present, there are no general recommendations for suitable anchoring systems (fixing materials, edge distances, etc.).

The aim of the research project was to work out practical recommendations for the implementation of window fastenings in clay unit masonry with high thermal insulating properties. The project was meant to work out holistic and practical solutions. This is why not only the load-bearing capacity of fasteners or fixing material in various types of bricks, but even recommendations should be formulated for fitters for fixing building elements, including the connection situation, e.g. downward in the spandrel area for these modern wall creators.

Extensive experimental examinations were foreseen for achieving the goals. In the course of the analyses,

- it was meant to work out the loading limits for the fixing or fastening solutions in clay unit masonry with high thermal insulating properties,
- as well as formulating practical construction-related recommendations for a solution that also takes special installation situations (e.g. fixing at the bottom in vertically perforated clay masonry units) into consideration.

The findings were meant to be worked out both by analyses on small samples, as well as by complete building element tests.

Moreover, the findings of the industry partner (e.g. the manufacturer of the fastener or fixing material) were also meant to be incorporated in the project.

2 Procedure

During the research project, comprehensive analyses were conducted on fixing windows in clay unit masonry with high thermal insulating properties. In the process, both "large chamber bricks" in which the cavities are filled with insulating material as well as "filigree bricks" that are offered with or without filling were taken into consideration.



Figure 1 Sample illustration of various types of structure reveal bricks
left: Large chamber bricks, filled
right: Filigree brick, unfilled

Apart from an analysis of the loads occurring at the fixing points, the load-bearing capacities of different fixing materials were obtained in the base with the help of small tests conducted on the parts concerned. This was done both for purely transverse tension as well as for fixtures in which the fastener or fixing material is exposed to bending stress.



Figure 2 Test for determining the load-bearing capacity of the fastening
Left: Purely transverse tension
Right: Tensile test with bending of the fixing material

Based on this, analyses of load-bearing capacity and durability were conducted on complete building elements comprising the wall as well as the installed window. In doing so, even alternative fixing concepts for group fastening as well as for fastening at the lower connection were analysed.



Figure 3 Example of a building element test, here a test set-up for measuring the deformation by simulating the vertical payload

3 Results

3.1 Analysis of the acting loads

Windows are exposed to stress by the most diverse impact of loads. These loads may also be caused by the dead load. However, windows and their fasteners or fixing materials have to withstand even external loads such as those caused by human beings or wind. The forces resulting from the impact have to be transferred via the fixing material and/or the support blocks into the base. In doing so, you have to pay attention to the direction of action of the resulting forces applied. They may occur both at the window level as well as at right angles to the window level.

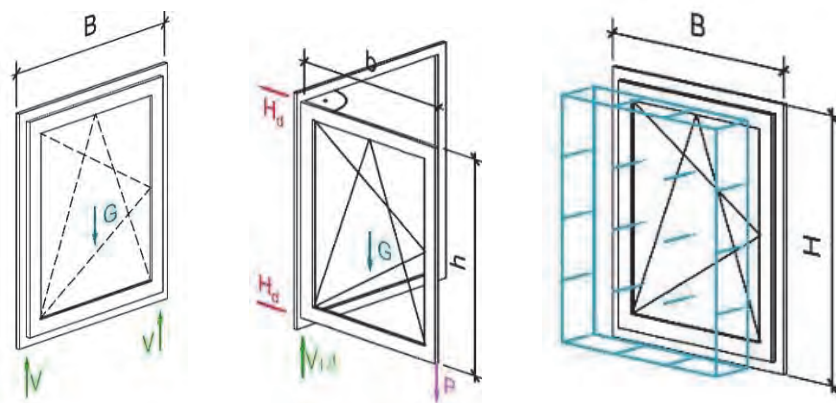

Figure 4 Loads on the window from the left to the right: Dead load, loads caused by opened sash, loads caused by wind

The following assumptions have formed the basis for analysing the loads acting on the window or fixing points:

- Standard insulating glass units (triple glazing) 30 kg/m²
- Profile weight 5.5 kg/running metre
- Vertical payload both 0 as well as 600 N (Class 3)
- Wind load B3 => 1.11 kN/m²
- No safety barrier function
- Position of the fixing material according to recommendation of the RAL code of practice for installation

The analysis of the load values occurring at the fixing points leads to the findings illustrated in the following.

- For a typical window (dimensions of approx. 1.2 m x 1.4 m), the load to be transferred by the fixing element due to the impact of wind is about 0.4 kN with fixing on all four sides, but with fixing on only 2 sides, the value increases to

approx. 0.6°kN. For a casement door (dimensions of approx. 1.3°m x 2.2°m), the load to be transferred by the fixing element due to the impact of wind is about 0.5°kN with fixing on all four sides, but with fixing on only 2 sides, the value increases to approx. 0.7°kN.

- In principle, the load to be transferred by the fixing material due to the impact of wind can be reduced by using more fixing points.
- As already shown, the loads arising from the dead load of the sash decrease with constant element width and with increasing element height. Hence, with the same element area ($W \times H$), the forces are lower for vertical configurations than for horizontal configurations. With purely wind load, in contrast, the loads to be transferred increase with constant element width and with increasing element height.
- For a window (dimensions of approx. 1.2°m x 1.4°m), the load to be transferred by the fixing element due to dead load without vertical payload is about 0.5°kN and is, thus, somewhat higher than the load that would occur by "only" wind load with fixing on all four sides. For a casement door (dimensions approx. 1.3°m x 2.2°m) the load due to dead load without any additional load is also approx. 0.5°kN.
- With an additional vertical payload P of 600 N to be considered, the load caused by the dead load and payload is significantly higher for all dimensions than the load caused by the impact of wind. This is applicable both to fixing of the window on all four sides as well as 2-sided fixing of the window.
- As a result of this, the outcome is that the load determined for dimensioning the fixing element with considering a payload of $P = 600^{\circ}\text{N}$ is described by the load case of dead load of the sash + payload.

3.2 Determining the load-bearing capacity

In line with the Eurocode, the dimensioning of the fixing point must consider both the boundary condition of the load-bearing capacity as well as the boundary condition of the fitness for use. For the boundary condition of the fitness for use, a maximum deformation of the fixing points under load of 3°mm is defined according to MO-02/1 at present. This requirement arises from ensuring the durability of the connection especially of the interior as well as exterior sealing between the window and masonry.

If the recommended load-bearing capacity for the failure of a fixing material in the fixing base is greater than the force for the permissible deformation of 3°mm, the dimensioning takes place on the basis of the deformation (boundary condition for fitness for use). In the process, the force for a deformation of 3°mm depends on the free length of the fixing material, i.e. in the first approximation, on the installation joint (Figure 5). This is why it is important to consider even the width of the installation joint for dimensioning.

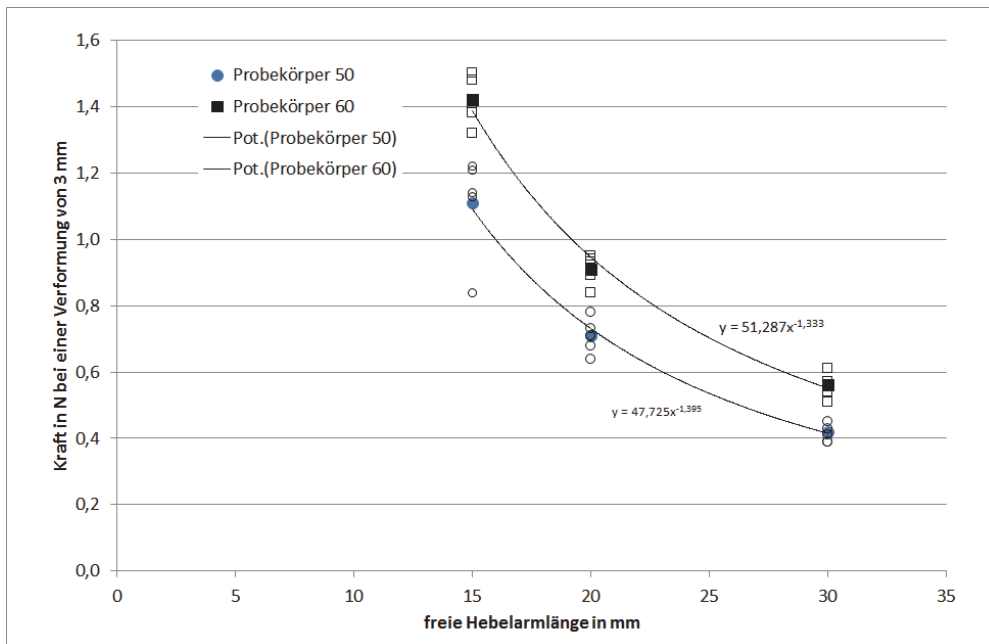

Figure 5 Graphical illustration of the correlation between the free lever arm length and load for a deformation of 3°mm. Apart from the mean values of the measurement (filled marker), even the individual values are entered (data points not filled up). In addition, compensation curves have been marked assuming a potential correlation.

Measurements of the load-bearing capacity at individual bricks have demonstrated that the deformation, with a joint width of above about 15 mm often represents the critical parameter for dimensioning the fixing material and not, as suspected earlier, the mere load-bearing capacity of the brick (Table 1). This is particularly true for special reveal bricks, which have an optimised pattern of cavities with respect to the mechanical properties (Figure 6).

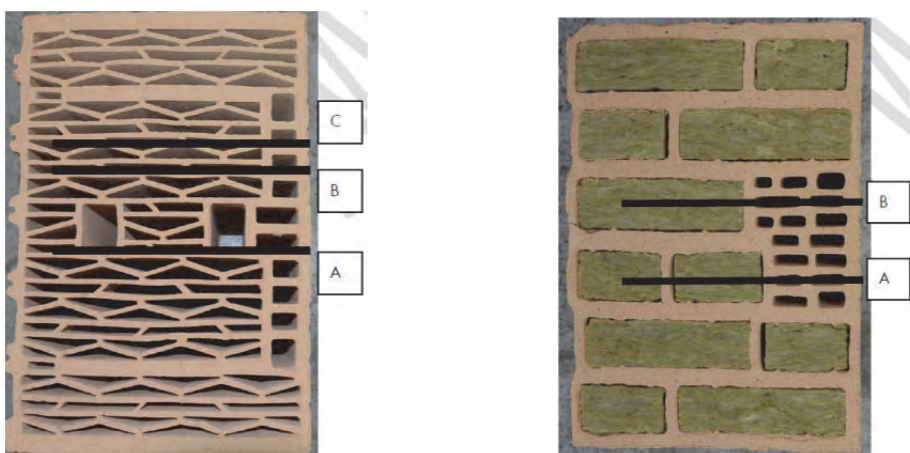

Figure 6 Reveal brick with pattern of cavities optimised with respect to the mechanical properties.
Left: Filigree brick (brick type no. 50),
Right: Large chamber brick (brick type no. 60)

Table 1 Determined dimensioning resistances

Series	Lever arm in mm	Mean value		Variation coefficient for		5.0% Fractile log		Dimensioning resistance	
		N_u in kN	N_{3mm} in kN	N_u in %	N_{3mm} in %	R_k in kN	$R_{k,3mm}$ in kN	R_d in kN	$R_{d,3mm}$ in kN
50_B_A	20	2.96	0.71	12.9	7.1	1.92	0.54	0.77	0.54
50_B_B	20	3.09	1.00	5.2	3.9	2.59	0.87	1.04	0.87
60_B_A	20	4.96	0.91	6.6	5.0	3.74	0.76	1.50	0.76
60_B_B	20	4.63	0.92	8.0	3.5	3.50	0.82	1.40	0.82

Analyses conducted on small-sized samples for the impact of the test specimen design have demonstrated that the "design of the test specimen" as well as details for carrying out the tensile tests may have a significant impact on the characteristic load-bearing capacity determined as well the type of failure. No generally valid statement can be derived about the degree of the impact due to the small sample. However, it is recommended, in principle, to determine the load-bearing capacity of clay unit masonry with high thermal insulating properties in the reveal at stone assemblies.



Figure 7 Test specimens in the analysis
Left: Single brick
Right: Assembly of 3 bricks

3.3 Alternative fixing solutions

The analysis conducted on the loads acting on the fixing points has shown that in several cases, the wind load is not the decisive parameter for dimensioning the fixing points. On the contrary, it is the load, which acts on the fixing points near the corner bearing or even stay bearing, by a sash opened at 90°, especially with an additional load, which is the critical load for dimensioning the fixing points. The forces occurring there are so large for typical window sizes that the loads can no longer be supported by only one fixing point. This is why "alternative fixing solutions" have been examined in the course of the research project.

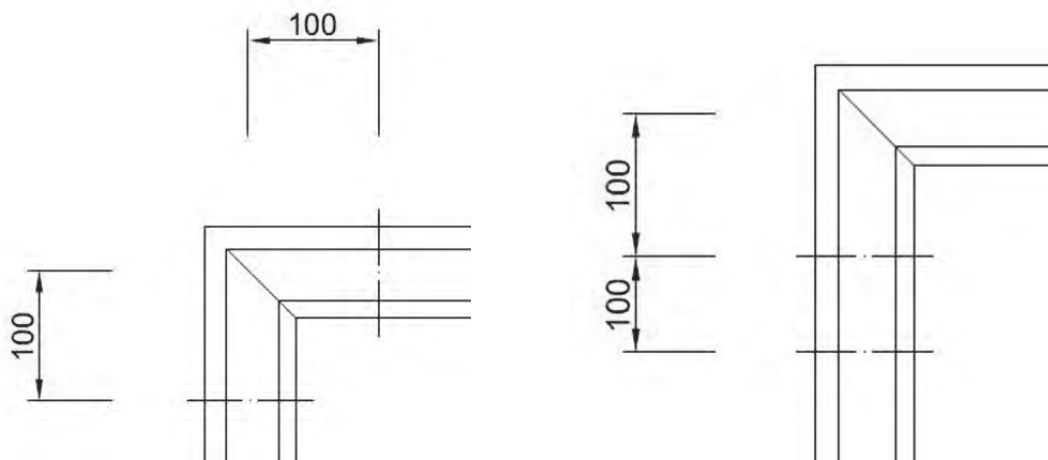

Figure 8 Group fastening for better load transfer with "point loads"
 Left: Symmetric group fastening using an example of a stay bearing
 Right: Double fastening using an example of a stay bearing

By using group fastening near the stay bearing or the corner bearing, the acting loads are divided over several fixing points. For group fastening in which the fixing points are located around the point of load introduction, you can assume uniform load distribution for the dimensioning. This is applicable, e.g. to fastening over the corner near the stay bearing. The load on the corner bearing can be divided to two fixing points with a window with bolt.

Similarly, load division can occur if the fixing material is not distributed symmetrically around the point of load introduction. If, for example, a second fixing point is set at the upper stay bearing at a distance of approx. 100°mm to the standard fixing point, the load at the standard fixing point gets reduced to about 70%. This is also applicable accordingly to the fastening near the corner bearing.

3.4 Component tests

With the help of the load-bearing capacities determined from the small tests conducted on parts (Table 1) dimensioning has been carried out for the window fastening for two types of windows and two types of bricks in accordance with the concept of the code of practice for installation. Based on the test program in accordance with the ift guideline MO 02-1, it should be examined whether the requirements with respect to the permissible deformation at the fixing points and even the durability of the fastening itself are met.

The impact implemented in the component tests (wind load, sash weight as well as vertical payload P) should be dimensioned in such a way that the design resistance of the fastening in both types of bricks analysed should be utilised almost completely if possible.

The component tests conducted (see Figure 9) have demonstrated that the theoretical (simplified) design model, in the context of the practical construction-related application,

adequately meets the deformations obtained in the component tests (see Table 2). Moreover, it could be demonstrated that fastening executed in accordance with the design concept in the reveal bricks optimised with respect to the mechanical properties has sufficient durability. The approach of group fastening for load distribution (via corner or double fastening) already presented has been certified by the supplementary component tests conducted.



Figure 9 Sample wall design with window element as well as the reveal bricks used

Table 2 Exemplary table for the deformations obtained at the measuring points at the start and end of the pressure-suction alternating load

First cycle	M1	M2	M3	M4	M5	M6	M7	M8	M9	M10	M11	M12	M13	M14	M15	M16
+1000 Pa	1.5	3.7	3.4	1.1	1.2	1.7	1.5	1.0	/	2.5	2.4	0.9	1.0	1.6	1.8	1.5
-1000 Pa	-1.7	-2.9	-2.5	-1.1	-1.2	-1.7	-1.3	-0.8	/	-1.5	-1.9	-0.5	-0.9	-1.5	-1.6	-1.6

Last cycle	M1	M2	M3	M4	M5	M6	M7	M8	M9	M10	M11	M12	M13	M14	M15	M16
+1000 Pa	1.6	3.8	3.5	1.2	1.3	1.8	1.5	1.0	/	2.6	2.4	1.0	1.0	1.6	1.7	1.5
-1000 Pa	-1.8	-3.3	-2.7	-1.1	-1.2	-1.6	-1.2	-0.8	/	-1.5	-1.9	-0.5	-0.9	-1.5	-1.7	-1.7

Remaining deformation	M1	M2	M3	M4	M5	M6	M7	M8	M9	M10	M11	M12	M13	M14	M15	M16
	0.4	0.4	0.5	0.2	0.2	0.3	0.3	0.5	/	0.3	0.3	0.5	0.3	0.1	0.1	0.3

All dimensions in mm

Nevertheless, there are significant variations for other comparative parameters in the course of the test of the small test on parts with the component tests.

Thus, there are considerably larger offsets in the "fixing point" observed with the small test for parts than in the components test.

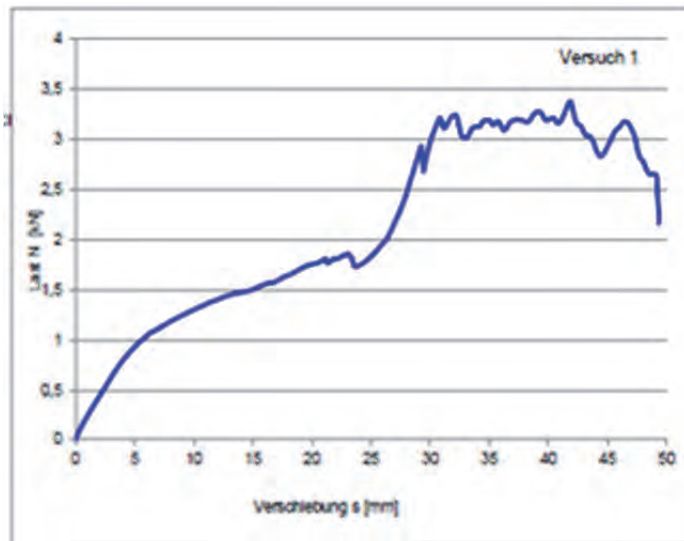

Figure 10 Typical force-displacement diagram in the course of the small test for parts

Moreover, there are distinct differences with respect to the deformation of the fixing elements at the end of the analyses. While the screws of the small test for parts near the point of load introduction were deformed considerably, there was no or only minor plastic deformation in the screws from the components test. Figure 11 compares the appearance of the fixing material after the small test of parts as well as after the components test.

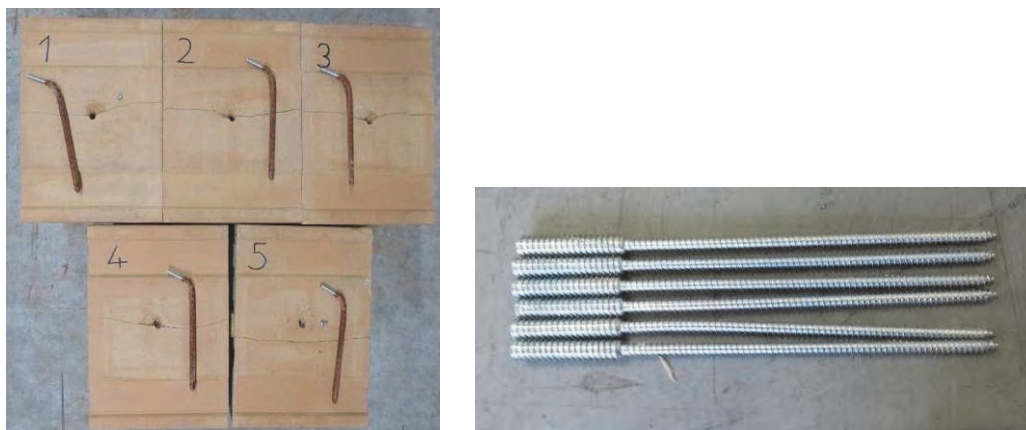

Figure 11 Appearance of the fixing material at the end of the respective test
Left: Small test of parts
Right: Components test

The different introduction of force in the fixing element is considered to be the cause for the deviations. While the load is introduced via an adapter that can freely rotated in the small test for parts, the load in the components test is introduced via the frame profile that cannot be rotated freely.

Hence, analyses were conducted in the course of the project in order to determine how existing torsion prevention affects the load-bearing capacity in the real window. When carrying out the tests, it was established, however, that the issue, unfortunately, could not be answered expediently with the adapter developed. This is why, unfortunately, in the

course of the research project, it was not possible to quantify the impact of torsion prevention in detail. Further analyses have to be conducted in the future for this purpose.

3.5 Fastening planner

The fitter or technician can fall back on a complimentary online calculation tool for determining the loads that act on the fixing points.

At www.ift-Montageplaner.de based on the input of the boundary conditions, the forces acting on the fixing points can be determined and output to a PDF file using the installation planner available at www.ift-Montageplaner.de. This results sheet is used in the course of the structural design of the window fastening for selecting a suitable fixing material.

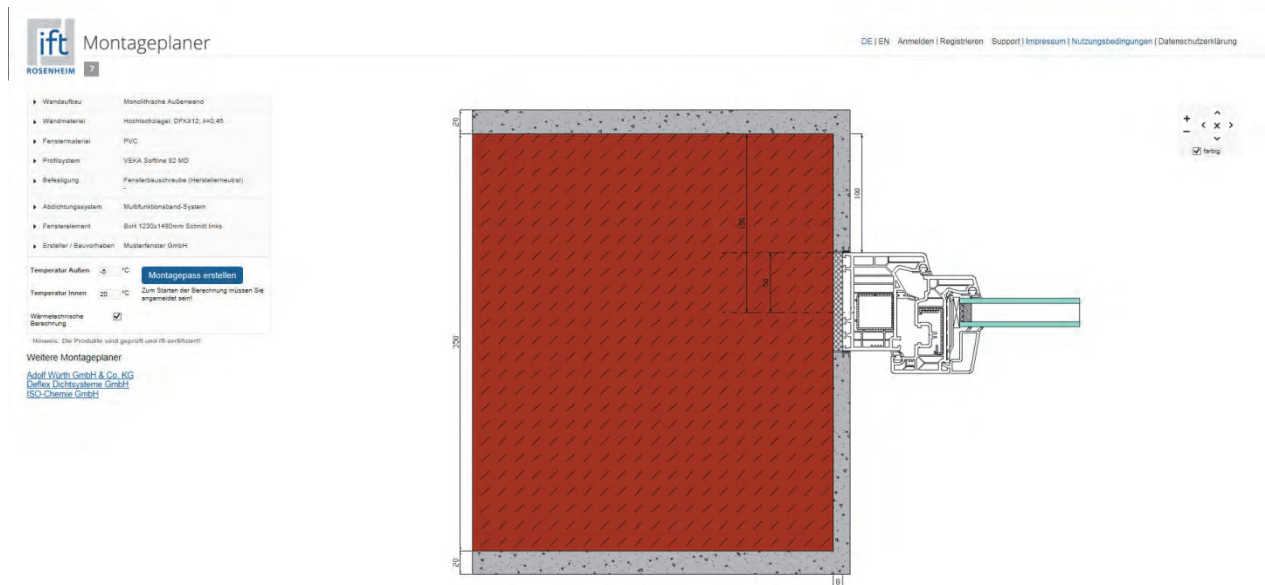

Figure 12 Home screen of the Installation Planner

4 Acknowledgement



The research project based on this report was sponsored by funds of the research initiative "Zukunft Bau" of the Bundesamt für Bauwesen und Raumordnung (Federal Office for Building and Regional Planning). SWD-10.08.18.7-13.27.

The authors are responsible for the contents of this report.

We would in particular like to thank the following industry partners who have supported the entire project financially and ideally and, thus, have contributed to its success:

	Arbeitsgemeinschaft Mauerziegel e. V. Reinhardtstraße 12-16 10117 Berlin
	Adolf Würth GmbH & Co. KG Reinhold-Würth-Straße 12–17 74653 KÜNZELSAU-GAISBACH Hr. Dr. Ing. Jürgen Küenzlen Hr. Thorsten Immel Hr. Thomas Kuhn

Furthermore, we would like to thank the following companies who have supported the project with the delivery of test specimens free of charge.

	Kneer-Südfenster Horst-Kneer-Straße 1 72589 Westerheim
	heroal - Johann Henkenjohann GmbH & Co. KG Österwieher Str. 80 33415 Verl
	VEKA AG Dieselstraße 8 48324 Sendenhorst



ift Rosenheim
Theodor-Gietl-Straße 7-9
83026 Rosenheim, Germany

Phone: +49 (0) 80 31 / 261-0
Fax: +49 (0) 80 31 / 261-290
Email: info@ift-rosenheim.de
www.ift-rosenheim.de

© ift Rosenheim 2018